

The LEHL2 is designed and listed for hazardous, marine, and wet locations. This product is ideal for replacing High Pressure Sodium (HPS) and Metal Halide (MH) fixtures for increased energy and maintenance savings. High luminous efficacy rating up to 160 Lm/W.

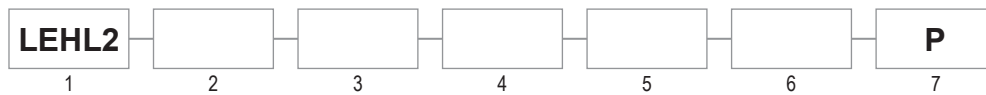

Inquire for specific DLC qualifying configurations



1 SERIES	2 SOURCE	3 VOLTAGE	4 CCT	5 OPTIC / BEAM	6 LENS	
LEHL2	L1: 80W L2: 120W L3: 150W L4: 200W	V1: 120-277VAC (50/60Hz) V2: 347-480VAC (50/60Hz)	3: 3,000K 4: 4,000K 5: 5,000K 57: 5,700K 65: 6,500K	RD: Red GN: Green BU: Blue AM: Amber	T1*: Type I T5: Type V (110°) * Only available with Clear Glass lens option	C: Clear Glass CP: Clear Polycarbonate D: Diffused Glass DP: Diffused Polycarbonate DL: Drop Lens (Glass)
7 MOUNT						
P: Pendant (3/4" NPT) ^{1,2}						
¹ Can be Ceiling or Surface mounted without additional mounting accessories.						
² Additional mounting options ordered separately, field installed.						

CERTIFICATIONS

UL844 / CSA-C22.2 No.137 (Hazardous)
 CI D2, Grps A, B, C, D
 CII D1, Grps E, F, G
 CII D2, Grps F, G
 CIII
 Simultaneous Presence
 T-Code: CI D2=T4A / CII D1=T4A
 UL1598 / CSA-C22.2 No.250 (Wet/Damp)
 UL1598A (Marine Outside Saltwater)
 DLC (inquire for specific part numbers)
 Lumen Maintenance (L70) >150,000 hrs. (calculated)
 CRI Ra>80
 -40°C to 65°C Ambient (L1 & L2 models)
 -40°C to 60°C Ambient (L3 model)
 -40°C to 55°C Ambient (L4 model)
 RH Ambient Humidity 5% to 95%
 IK08 (Glass) IK10 (Polycarbonate)
 IP66
 FCC

CONSTRUCTION

Copper-free, corrosion resistant aluminum
 Powder coat gray (RAL7037)
 High temperature silicone gasketing
 All exposed fasteners are 316 stainless steel
 Thermal shock and impact resistant lenses
 3/4" NPT hubs (standard)
 (1) Top / (5) Side w/ NPT plugs pre-installed
 Weights: 80/120W=20lbs. 150/200W=23lbs.

ELECTRICAL

120-277 / 347-480VAC
 Dimming (standard) 0-10V (10-100%)
 (Dimming leads capped inside driver housing)
 10Kv surge protector built in - Standard
 3Ft. 3-Wire whip standard, factory installed

FEATURES

High lumen output up to 160 Lm/W
 Anti-corrosion tested 1,000 hrs.
 Mounting: Pendant, Stanchion, Ceiling, Yoke, Wall
 15° Yoke Adjustments (180° total)
 5 Year Warranty

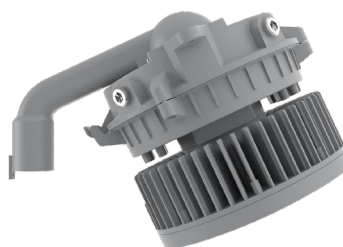

Shown with 25° Stanchion Mount
(Mount ordered separately, field installed)

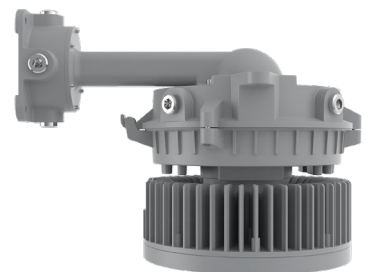

Shown with 90° Wall Mount
(Mount ordered separately, field installed)



LEHL2

HAZARDOUS LOCATION

Chemical Processing • Industrial • Oil / Gas • Shipyards / Marine • Water Treatment

PERFORMANCE

Lumen Output Table								
Source	Wattage (W)	Voltage (VAC) 50/60Hz	CCT	Lumen Output* (Lm)				
				Clear Glass	Clear Poly	Diffused Glass	Diffused Poly	Drop Lens
L1	80	V1 (120-277)	5,000K	12,630	12,290	11,210	8,830	12,290
L2	120		5,000K	19,230	18,440	18,560	13,250	16,970
L3	150		5,000K	23,630	22,550	22,740	16,120	20,950
L4	200		5,000K	28,940	27,720	27,800	19,290	27,795
L1	80	V2 (347-480)	5,000K	12,920	12,340	11,450	8,900	12,550
L2	120		5,000K	19,210	18,420	18,650	13,260	17,170
L3	150		5,000K	23,920	22,930	22,960	16,330	21,190
L4	200		5,000K	31,100	29,740	29,860	20,740	27,300

*Nominal Values

Amperage Table		
Source (Wattage)	Voltage (VAC) 50/60Hz	Input Current (A)
L1 (80)	120-277	.67 - .29
	347-480	.23 - .17
L2 (120)	120-277	1.00 - .44
	347-480	.36 - .25
L3 (150)	120-277	1.25 - .54
	347-480	.43 - .31
L4 (200)	120-277	1.67 - .72
	347-480	.58 - .42



Shown with Glass Drop Lens

DIMENSIONS - (STANDARD)

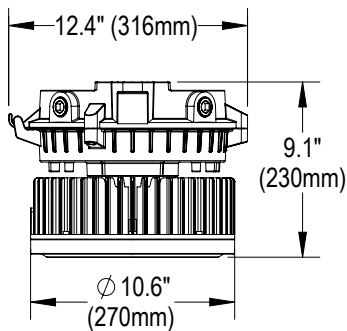

FLAT LENS

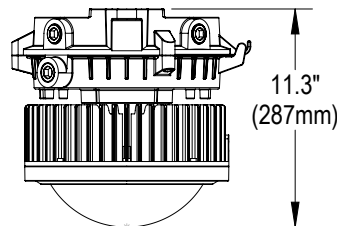

DROP LENS

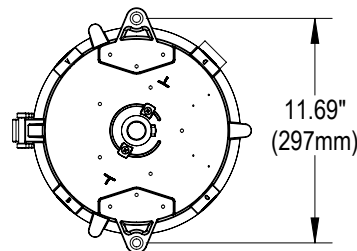

CEILING / SURFACE MOUNT

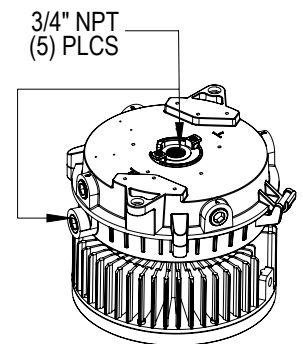

CONNECTION

LEHL2

HAZARDOUS LOCATION

Chemical Processing • Industrial • Oil / Gas • Shipyards / Marine • Water Treatment



MOUNTING

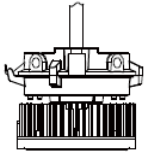

Pendent

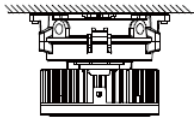

Ceiling

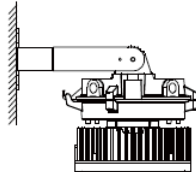

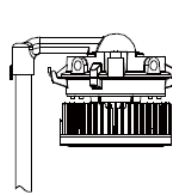

Yoke Bracket



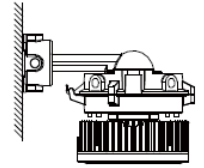
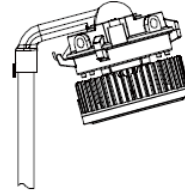



Stanchion

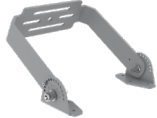

Wall

ACCESSORIES - (Field Installed, Order Separately)		
Part Number	Description	
WG07	Stainless steel wire guard (flat lens)	
WG08	Stainless steel wire guard (globe lens)	
SC01	Stainless steel safety cable kit	

UNIVERSAL MOUNTING ACCESSORIES (Field Installed, Order Separately)		
Part Number	Description	
WL90-M	Wall Mount - 90° Gray Painted A356 Aluminum AL	
SN2503	Stanchion Mount - 25°: 1.25" NPT Gray Painted A356 Aluminum AL	
SN2504	Stanchion Mount - 25°: 1.50" NPT Gray Painted A356 Aluminum AL	
SN9003	Stanchion Mount - 90°: 1.25" NPT Gray Painted A356 Aluminum AL	
SN9004	Stanchion Mount - 90°: 1.50" NPT Gray Painted A356 Aluminum AL	
PB03	U-Bracket 304 Stainless Steel	
SN01	Slip Fitter Mount Bracket (Powder Coated Grey) Fits 2 3/8" (60mm) Outside Diameter Stanchion (non-adjustable) Includes 316SS Hardware Note! Requires PB03 U-Bracket	

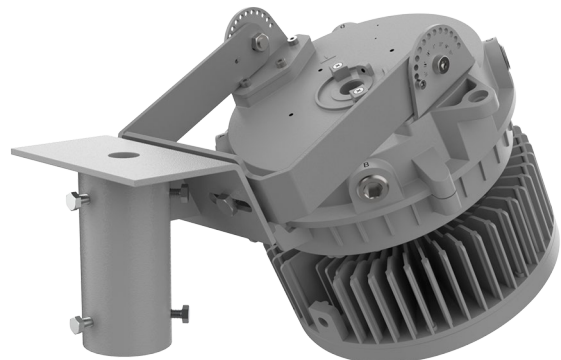

Shown with #PB03 + #SN01