

379 SERIES



WET / DAMP LIGHTING

- Fixture rated for wet locations
- Glass fiber reinforced polyester housing
- Impact resistant acrylic lens standard. Optional Polycarbonate lens available.
- UL listed for U.S. and Canada
- IP 67
- NSF slash zone
- Closed cell polyurethane gasket with no seams
- Optional emergency battery backup ballast
- Available in 120, 277, 347 and 480 volt



APPLICATIONS

Warehouses, Paper Mills
Parking Garages, Tunnels
Locker Rooms
Water Treatment Plants
Kitchens, Showers
Food Processing
Marinas/Offshore Facilities
Breweries and Bottling
Livestock Containment
Hospitals and Schools



www.ldpi-inc.com



Bright Ideas Innovative Solutions



The 379 Series is a perfect fixture for a multitude of applications desiring a wet/damp fixture or an enclosed high bay fixture. The 379 is a glass fiber reinforced product with injection molded lens options for precise detail and strength. The lenses also have frosted ends, lineal prism sides and an optically clear face for maximum photometric output. All hardware is stainless steel with tamper resistant latches. The gear tray hinges at both sides with tool-less latches for ease of accessibility and maintenance. Ask us about our customized performance reflector option. Lamps not included.

379 SERIES DIMENSIONS

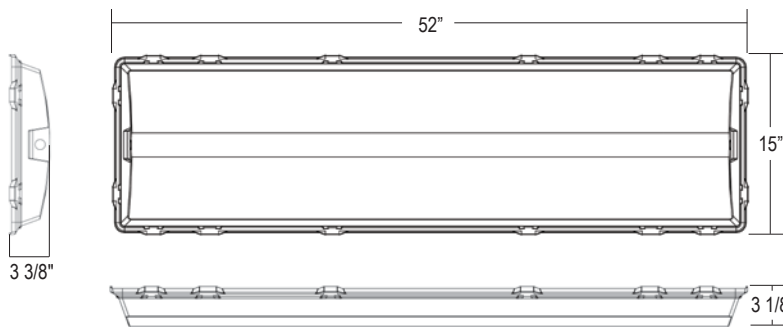

Dimensions are nominal

STANDARD MOUNTING: 6986 standard bracket for cable hang (cable NOT included) or bracket with "V" hook - not shown

ADDITIONAL CEILING MOUNTS:

Ceiling mount system kit: 8366: stainless steel ceiling mounting brackets, sealing washer, 1/2" conduit hub, 1/2" conduit hub plug and stainless steel support plate.

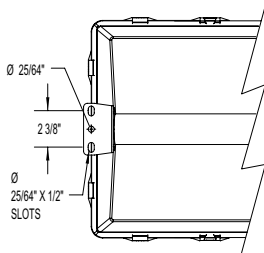

Ceiling mount system kit 8367 - Square bend U bolt

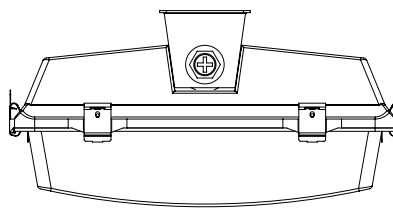

Ceiling mount system kit 8368 - U bolt

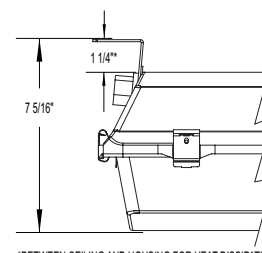

*BETWEEN CEILING AND HOUSING FOR HEAT DISSIPATION

Ceiling mount system kit 8369 - 3 Ft. rod

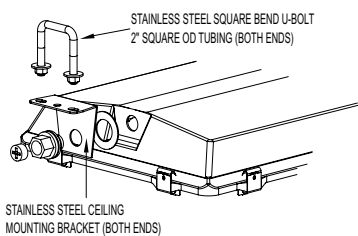

STAINLESS STEEL CEILING MOUNTING BRACKET (BOTH ENDS)

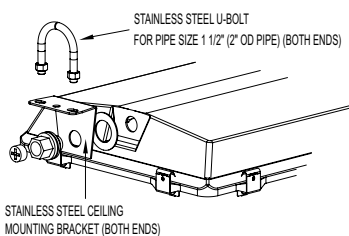

STAINLESS STEEL CEILING MOUNTING BRACKET (BOTH ENDS)

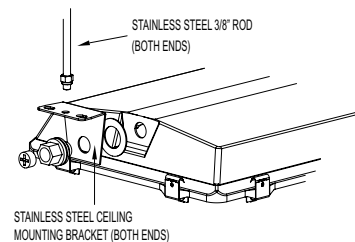

STAINLESS STEEL CEILING MOUNTING BRACKET (BOTH ENDS)



www.ldpi-inc.com
sales@ldpi-inc.com
1-800-854-0021
(F) 715-839-8145