

C IND SERIES

COMPACT INDUSTRIAL LIGHTS

DATE: _____ PROJECT MGR: _____

JOB: _____

PN: _____

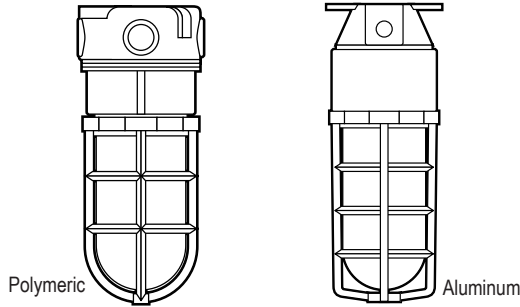

APPLICATIONS

Chemical Plants
 Oil Refineries
 Offshore Platforms
 Waste Treatment Facilities
 Beef & Poultry Processing
 Breweries/Beverage Plants
 Grain & Corn Processing
 Tunnels and Walkways
 Steel Mills, Foundries
 Shipyards & Shipbuilding
 Airplane Manufacturing

The C IND Series is a compact industrial fixture available with either a cast aluminum or glass reinforced polymeric housing rated for hazardous locations. Lamp options for the C IND Series are incandescent, compact fluorescent and high pressure sodium. The modular design allows you to pick fixture components to build a fixture for your specific application.

SPECIFICATIONS

LISTINGS: Class I, Div. 2, Groups A, B, C, D
 Class I, Zone 2, Groups IIA, IIB, IIC
 Class II, Div. 2, Groups F, G
 UL 844 listed U.S. for hazardous locations
 UL 1598A listed U.S. for marine locations
 Enclosed and gasketed
 Type 4 (water tight)
 IP66



ELECTRICAL: HPS (high pressure sodium) 35, 50 watts
 CFL (compact fluorescent) 9 watts 120 volts / 60 Hz (only)
 18-32 watts 120 or 277 volts / 60 Hz
 Incandescent 150 watts (max) 250 volts (max)
 Optional ratings: contact factory

HOUSING: To meet the demands of corrosive and adverse industrial environments
 Polymeric: glass reinforced polymeric
 Aluminum: cast aluminum, polyester powder finish

GUARD: Glass reinforced polymeric

REFLECTOR: Molded acrylic plastic

GLOBES: Clear glass (standard). Also available in tempered glass and polycarbonate plastic for splashdown and thermal shock locations. Colored glass globes available for visual signaling and identification needs.

MOUNTING: Pendant, ceiling or wall mount

FEATURES: Gasketing: Silicone and neoprene gaskets for reliable water tight and dust tight sealing in wet, corrosive areas.
 Modular fixture components: all fixture components are modular for installation and stocking flexibility.
 Maximum light, Compact size: up to 50 watt HPS, 32 watt fluorescent or 150 watt incandescent in a compact fixture assembly.

OPTIONS: Unipak packaging
 Prismatic reflector
 Stainless steel wire guard
 Cast bronze housings (minimum Qty requirements: see ordering notes)

COMPACT INDUSTRIAL LIGHTS



C IND SERIES

COMPACT INDUSTRIAL LIGHTS



www.ldpi-inc.com

Polymeric Fixture

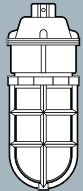
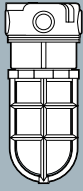
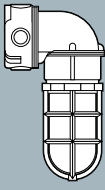
Mounting Style	Lamp Type	Lamp Watts	Hub Size	Order As Components						Complete Unipak Fixture Assembly
				Housing Assembly	Mount	Junction Box	Globe	Guard	Lamp	
	Compact Fluorescent	9	3/4"	DN09F1	PN2	-	GG15C	GN	VPL-9	DN09F1-GCN-P2E
		18	3/4"	DN18F1					PLC-18	DN18F1-GCN-P2E
		26	3/4"	DN26F1					PLC-26	DN26F1-GCN-P2E
		32	3/4"	DN32F1					PLC-32	DN32F1-GCN-P2E
	HPS	35	3/4"	DN35S1	LU-35-MED	DN35S1-GCN-P2E				
		50	3/4"	DN50S1	LU-50-MED	DN50S1-GCN-P2E				
	Incandescent	150	3/4"	DN150K-P2	-	-	-	-	DN150K-GCN-P2U	
		Compact Fluorescent	9	3/4"	DN09F1	JN2	-	GG15C	GN	VPL-9
18			3/4"	DN18F1	PLC-18					DN18F1-GCN-C2E
26			3/4"	DN26F1	PLC-26					DN26F1-GCN-C2E
32			3/4"	DN32F1	PLC-32					DN32F1-GCN-C2E
HPS		35	3/4"	DN35S1	LU-35-MED	DN35S1-GCN-C2E				
		50	3/4"	DN50S1	LU-50-MED	DN50S1-GCN-C2E				
Incandescent		150	3/4"	DN150K-C2	-	-	-	-	DN150K-GCN-C2U	
		Compact Fluorescent	9	3/4"	DN09F1	WN	JN2	GG15C	GN	VPL-9
	18		3/4"	DN18F1	PLC-18					DN18F1-GCN-W2E
	26		3/4"	DN26F1	PLC-26					DN26F1-GCN-W2E
	32		3/4"	DN32F1	PLC-32					DN32F1-GCN-W2E
	HPS	35	3/4"	DN35S1	LU-35-MED	DN35S1-GCN-W2E				
		50	3/4"	DN50S1	LU-50-MED	DN50S1-GCN-W2E				
	Incandescent	150	3/4"	DN150K-P2	-	-	-	-	DN150K-GCN-W2U	

Ordering Notes:

- All C-IND Series Polymeric products are shipped as separate components unless "Unipak®" packaging catalog numbers are specified. Minimum quantity per Unipak catalog number is 25.
- Compact fluorescent and HPS Complete Unipak® Fixture Assemblies listed above are shipped complete with lamp and Unipak packaging. To specify Complete Unipak Fixture Assemblies without lamp, change the "E" at the end of the catalog number to "U". Example: DN32F1-GCN-P2U.
- Incandescent Complete Unipak® Fixture Assemblies listed above are shipped with Unipak packaging without lamp.
- All catalog numbers listed above are 120VAC, 60 Hz. 18 watt, 26 watt, and 32 watt fluorescent C-IND fixtures are also available in 277VAC, 60 Hz versions. To order, change the catalog numbers as follows: For 277VAC, 60 Hz: Change "F1" in catalog number to "F4". Example DN32F4
- All catalog numbers listed above are with standard clear glass globe. To substitute clear polycarbonate globe, order GPV10C. To substitute tempered clear glass globe, order GG15CH. For colored glass globes, substitute the first letter of the color for the "C" in catalog number GG15C. Example: For Red, GG15R. (Colors available are Red, Green, Blue, Amber.)
- Refer to C-IND "Temperature Performance" chart on page 77 for details on globe material and position limitations.



C IND SERIES

COMPACT INDUSTRIAL LIGHTS

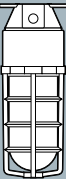

www.ldpi-inc.com

Aluminum Fixture

Mounting Style	Lamp Type	Lamp Watts	Hub Size	Order As Components				Complete Unipak Fixture Assembly
				Housing/Mounting Assembly	Globe	Guard	Lamp	
 Pendant	Compact Fluorescent	9	3/4"	DA09F1-P2	GG15C	GN	VPL-9	DA09F1-GCN-P2E
		18	3/4"	DA18F1-P2			PLC-18	DA18F1-GCN-P2E
		26	3/4"	DA26F1-P2			PLC-26	DA26F1-GCN-P2E
		32	3/4"	DA32F1-P2			PLC-32	DA32F1-GCN-P2E
	HPS	35	3/4"	DA35S1-P2			LU-35-MED	DA35S1-GCN-P2E
		50	3/4"	DA50S1-P2			LU-50-MED	DA50S1-GCN-P2E
	Incandescent	150	3/4"	DA150K-P2			-	DA150K-GCN-P2U
	 Ceiling	Compact Fluorescent	9	3/4"			DA09F1-C2	GG15C
18			3/4"	DA18F1-C2	PLC-18	DA18F1-GCN-C2E		
26			3/4"	DA26F1-C2	PLC-26	DA26F1-GCN-C2E		
32			3/4"	DA32F1-C2	PLC-32	DA32F1-GCN-C2E		
HPS		35	3/4"	DA35S1-C2	LU-35-MED	DA35S1-GCN-C2E		
		50	3/4"	DA50S1-C2	LU-50-MED	DA50S1-GCN-C2E		
Incandescent		150	3/4"	DA150K-C2	-	DA150K-GCN-C2U		
 Wall Mount w/Box		Compact Fluorescent	9	3/4"	DA09F1-W2	GG15C	GN	
	18		3/4"	DA18F1-W2	PLC-18			DA18F1-GCN-W2E
	26		3/4"	DA26F1-W2	PLC-26			DA26F1-GCN-W2E
	32		3/4"	DA32F1-W2	PLC-32			DA32F1-GCN-W2E
	HPS	35	3/4"	DA35S1-W2	LU-35-MED			DA35S1-GCN-W2E
		50	3/4"	DA50S1-W2	LU-50-MED			DA50S1-GCN-W2E
	Incandescent	150	3/4"	DA150K-W2	-			DA150K-GCN-W2U

Ordering Notes:

- All C-IND Series Aluminum products are shipped as separate components unless "Unipak®" packaging catalog numbers are specified. Minimum quantity per Unipak catalog number is 25.
- Compact fluorescent and HPS Complete Unipak® Fixture Assemblies listed above are shipped complete with lamp and Unipak packaging. To specify Complete Unipak Fixture Assemblies without lamp, change the "E" at the end of the catalog number to "U". Example: DA32F1-GCN-P2U.
- Incandescent Complete Unipak® Fixture Assemblies listed above are shipped with Unipak packaging without lamp.
- Cast Bronze C-IND fixtures are available; minimum order quantity is 50 per catalog number.
- Metric conduit entries are available on C-IND aluminum and bronze fixtures. Contact LDPI for catalog number and pricing assistance.
- All catalog numbers listed above are 120VAC, 60 Hz. 18 watt, 26 watt, and 32 watt fluorescent C-IND fixtures are also available in 277VAC, 60 Hz versions. To order, change the catalog numbers as follows: For 277VAC, 60 Hz: Change "F1" in catalog number to "F4". Example DA32F4
- All catalog numbers listed above are with standard clear glass globe. To substitute clear polycarbonate globe, order GPV10C. To substitute tempered clear glass globe, order GG15CH. For colored glass globes, substitute the first letter of the color for the "C" in catalog number GG15C. Example: For Red, GG15R. (Colors available are Red, Green, Blue, Amber.)
- Refer to C-IND "Temperature Performance" chart on page 77 for details on globe material and position limitations.
- All Wall Mount catalog numbers listed above are with outlet box. If outlet box is not required, change "W2" in catalog number to "WA". Example: DA32F1-WA.

C IND SERIES





COMPACT INDUSTRIAL LIGHTS





www.ldpi-inc.com

Polymeric Mounting Components

Gaskets and screws included with polymeric mounting components



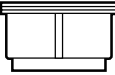





Mounting Style	Hub Size	Catalog Number
Pendant 	3/4"	PN2
Ceiling 	3/4"	JN2
Wall Arm 	No Hub	WN
Wall Box 	3/4"	JN2

Polymeric Housing/Mounting Assemblies



Lamp Type	Lamp Watts	Catalog Number
 Compact Fluorescent	9	DN09F1
	18	DN18F1
	26	DN26F1
	32	DN32F1
	35	DN35S1
 HPS	50	DN50S1
	150	DN150K-P2 (3/4" pendant) DN150K-C2 (3/4" ceiling) DN150K-W2 (3/4" wall)
 Incandescent		

Globes and Guards

(for Polymeric and Aluminum Fixtures)

Description	Catalog Number
 Clear glass globe	GG15C
 Tempered glass globe	GG15CH
 Clear polycarbonate globe (Standard with stainless steel guard only)	GPV10C
 Polymeric guard (Standard for all C-IND assemblies)	GN
 Cast aluminum guard (Optional)	GA
 Stainless steel wire guard (Optional for polymeric, aluminum or bronze)	GW
 Prismatic polycarbonate reflector (Pendant, ceiling only)	RP
 Prismatic reflector with guard (Pendant, ceiling only)	RPG

Aluminum Housing/Mounting Assemblies

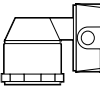
Mounting Style	Lamp Watts	Hub Size	Housing/Mounting Assembly
 Pendant Mount	9	3/4"	DA09F1-P2
	18	3/4"	DA18F1-P2
	26	3/4"	DA26F1-P2
	32	3/4"	DA32F1-P2
	35	3/4"	DA35S1-P2
	50	3/4"	DA50S1-P2
 Ceiling Mount	150	3/4"	DA150K-P2
	9	3/4"	DA09F1-C2
	18	3/4"	DA18F1-C2
	26	3/4"	DA26F1-C2
	32	3/4"	DA32F1-C2
	35	3/4"	DA35S1-C2
 Wall Mount w/Box	50	3/4"	DA50S1-C2
	150	3/4"	DA150K-C2
	9	3/4"	DA09F1-W2
	18	3/4"	DA18F1-W2
	26	3/4"	DA26F1-W2
	32	3/4"	DA32F1-W2
	35	3/4"	DA35S1-W2
	50	3/4"	DA50S1-W2
	150	3/4"	DA150K-W2

Temperature Performance

Lamp Type	Lamp Watts	Ambient		Supply Wire Temp.	T-Numbers		
		Min.	Max.		Global Material/Position	Class I, Div. 2	Class II, Div. 2
Compact Fluorescent	9	0°C	40°C	90°C	Glass or Plastic - Any Position	T3C	T3C (F,G)
	18	-18°C	40°C	90°C		T3C	T3C (F,G)
	26	-18°C	40°C	90°C		T3C	T3C (F,G)
	32	-18°C	40°C	90°C		T3C	T3C (F,G)
High Pressure Sodium	35	-40°C	40°C	90°C	Glass or Plastic - Any Position	T3	T3C (F,G)
	50	-40°C	40°C	90°C		T3	T3C (F,G)
Incandescent	60	-40°C	40°C	90°C	Glass or Plastic - Any Position	T3C	T3C (F,G)
	100	-40°C	40°C	90°C	Glass - Any Position Plastic - Base Up Only	T3C	T3C (F,G)
	150	-40°C	40°C	90°C	Glass Only - Any Position	T3	T3C (F,G)

Lamp Data

Lamp Type	Lamp Watts	Lamp Cat. Number	Lamp Base Description	Initial Lumens	Lumens per Watt	Rated Life (in hours)
Compact Fluorescent	9	VPL-9	G23	600	66.7	10,000
	18	PLC-18	G24q-2	1160	64.4	10,000
	26	PLT-26	GX24q-3	1610	61.9	10,000
	32	PLT-32	GX24q-3	2200	68.8	10,000
	35	LU-35-MED	-	2250	64.3	16,000
High Pressure Sodium	50	LU-50-MED	-	4000	80.0	24,000+
	60	-	-	865	14.4	1,000
Incandescent	100	-	-	1710	17.1	750
	150	-	-	2850	19.0	750

C IND SERIES

COMPACT INDUSTRIAL LIGHTS



www.ldpi-inc.com

Polymeric Dimensions

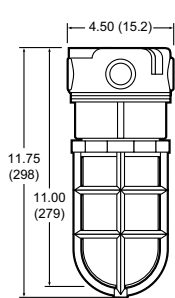

Ceiling
Fluorescent, HID

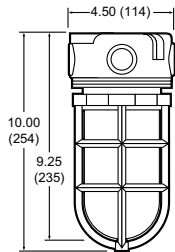

Ceiling
Incandescent

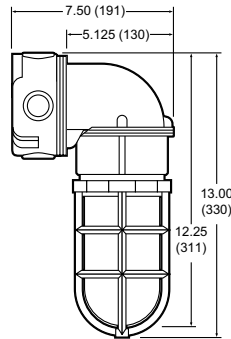

Wall
Fluorescent, HID

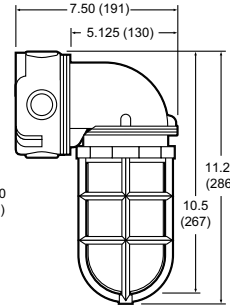

Wall
Incandescent

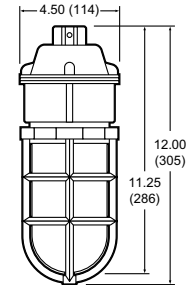

Pendant
Fluorescent, HID

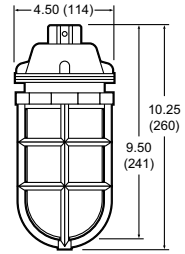

Pendant
Incandescent

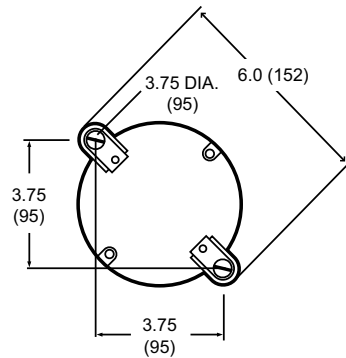

Polymeric Box
Mounting Detail

Aluminum Dimensions

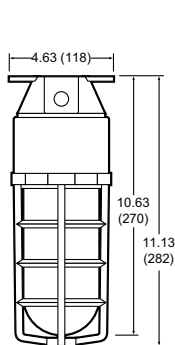

Ceiling
Fluorescent/HID

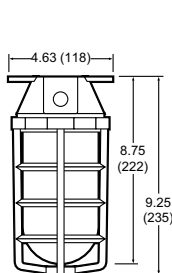

Ceiling
Incandescent

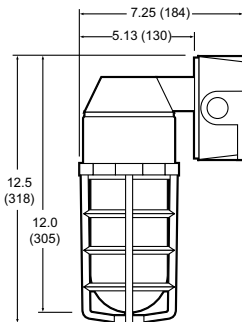

Wall
Fluorescent/HID

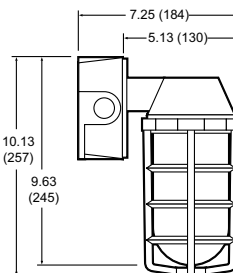

Wall
Incandescent

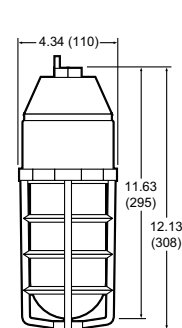

Pendant
Fluorescent/HID

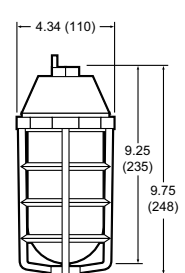

Pendant
Incandescent